

Terrapalme

Home and Garden Design



Classic Red



Turquoise



Gold Coloured



Terra Cotta



Mystic

Keramikgefäße



Index

Specifications	4
Production of pottery	6
Amora	10
Blue	11
Anthracite	12
Black Shiny	16
Brown	18
Classic Red	19
Bullet Grey	20
De Luxe	22
Doppio Bordo	24
Gold Coloured	28
Laos	30
Lime	32
Terra Cotta	33
Metal Glaze	34
Mystic	36
Sepia	38
Turquoise	42
White	44
Sale	46
Online webshop	48
Recommendations	50

Specifications

These planters are making a real comeback thanks to their sturdy and vintage character. Ceramics can be used both indoor and outdoor.

Ceramics pottery are made entirely by hand, according to traditional methods, in Vietnam and China.

Ceramics are fire resistant, an important characteristic given the increasingly stricter requirements imposed on shopping centres, hotels and office premises.



Indoor



Outdoor



Recycle



Handmade



Heavy



Production of pottery

Take a look behind the scenes



Our assortment of ceramic planters comprises a large number of models in various colours and dimensions. All this pottery is made by hand according to traditional methods. Take a look behind the scenes at how it is made.

There are various types of clay that are used in just as many different products. The coarser types are often used for making planters. Irregularities are removed from the clay and it is subsequently pressed into large blocks. Slices are cut from these blocks and placed in moulds by hand. Then it is a question of drying, the time this takes depending on the weather. In the rainy season, it takes longer because of the high air humidity. The mould is carefully removed, revealing the rough version of the planter, which is finished off using moist tools. A second drying time follows.



After a few days, the clay is dry enough to treat with the glaze. As soon as this is dry, the planters are placed in a wood-fired oven and the oven is bricked up except for a very small opening. Wood is fed in through this opening for 24 hours to keep the fire burning.

Its place in the oven ultimately determines the appearance of the ceramic planter. If it is close to the fire, the planter will shrink more and the colour will be intenser. Sparks from the fire create an unusual texture in the glaze. The potter has no control over this process, the result being that no two products are identical. Each planter is unique.

The planters have to cool down in the oven for at least 12 hours. Emptying the oven is a tough job and a very hot one since the planters still radiate heat that would delight the average sauna visitor.

Once they have cooled down and passed the last check, the planters are ready and are transported by sea container from Asia to Europe. Each individual planter will later form an exclusive element in a lovingly-created interior.



The temperature of the oven is around 1,200 degrees Celsius

Ceramics
Amora
6AMO

10



Ceramics
Blue
6BLK

11

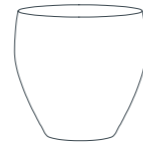

New
Dimensions

Ceramics
Anthracite
6ZWK

12



New Models

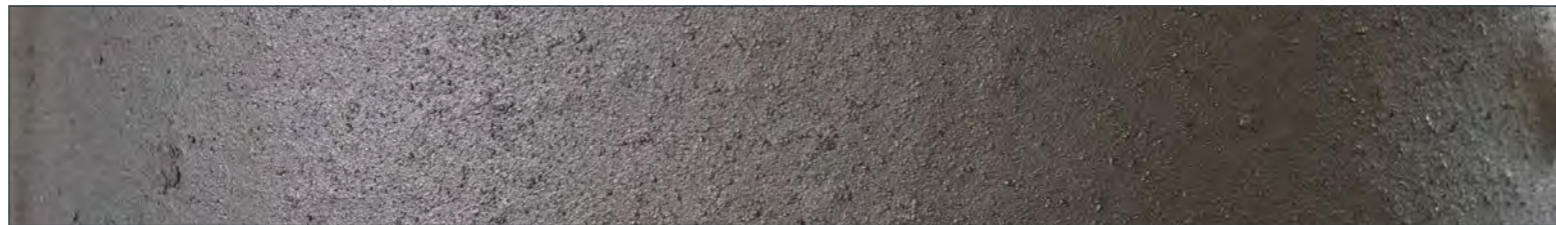
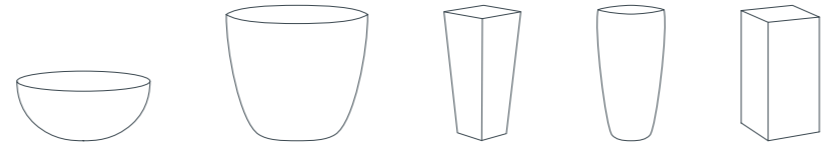



Gold Coloured

Ceramics
Black Shiny
6ZWG

16



New Models

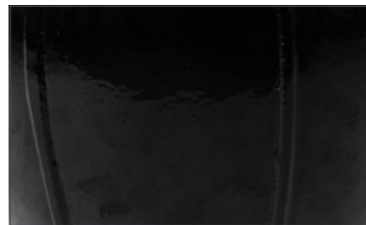
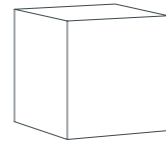

Ceramics
Brown
6BRK

18



Ceramics
Classic Red
6CLR

19



New
Models

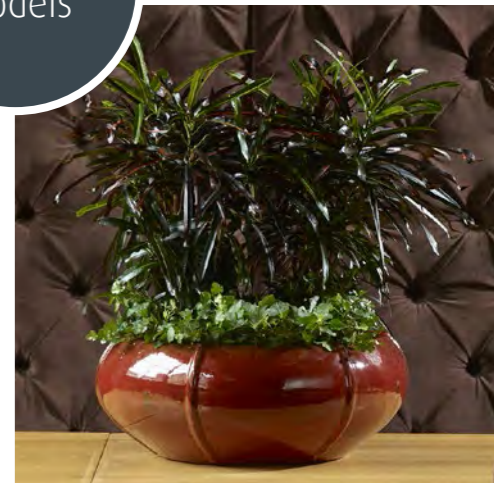
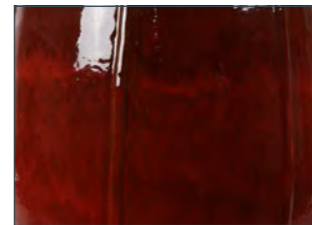
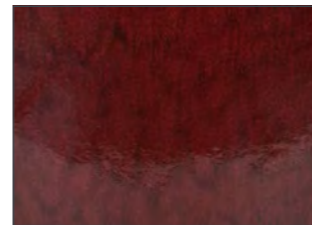
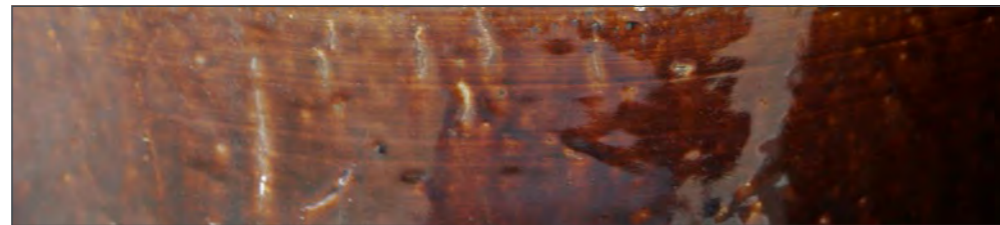

Ceramics
Bullet Grey
6KBG

20

New
Collection

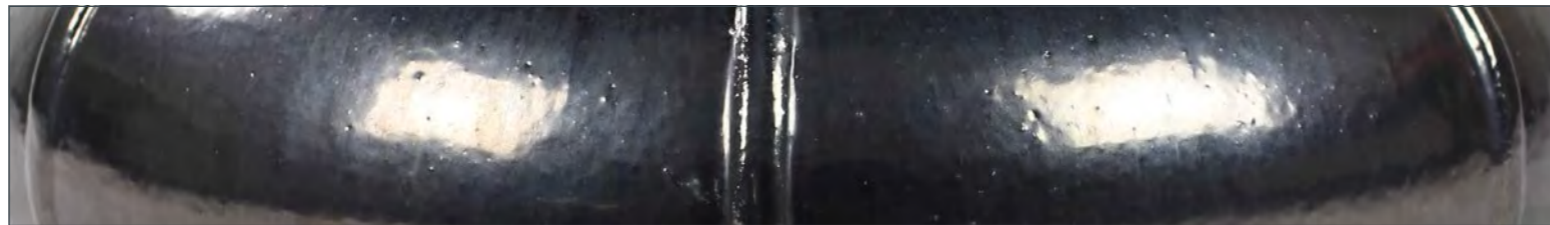

Ceramics
De Luxe
6KDL

22

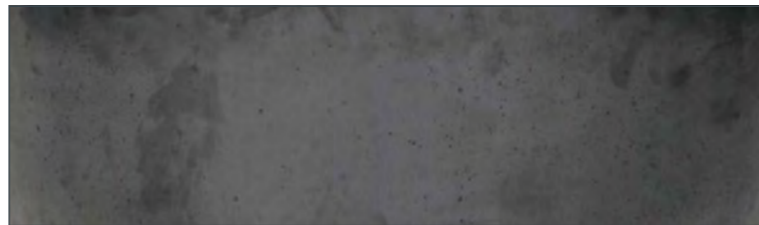
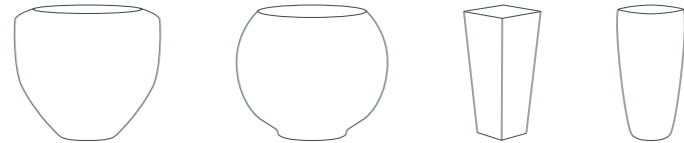

Ceramics
Doppio Bordo
6TDB

24

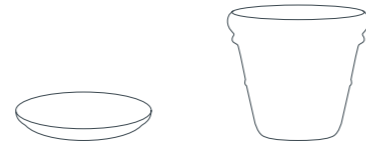

Doppio Bordo includes many more planters. Ask our sales team for more information. sales@nieuwkoop-europe.com





Ceramics
Gold Coloured
6KGO

28

New
Collection



Ceramics
Laos
6LAO

30



Ideal as
center
piece



Ceramics
Lime
6LIM

32

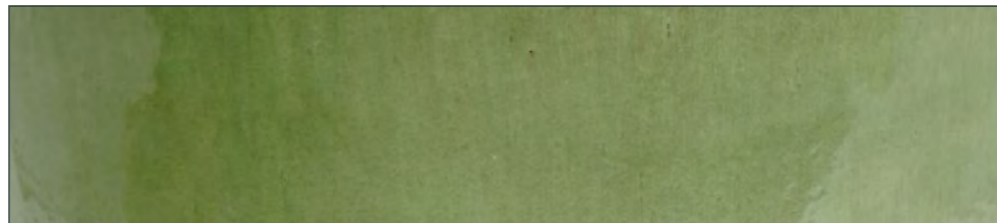

Ceramics
Terra Cotta
6TER

33



Ceramics
Metal Glaze
6KMG

34



Ideal as
center
piece

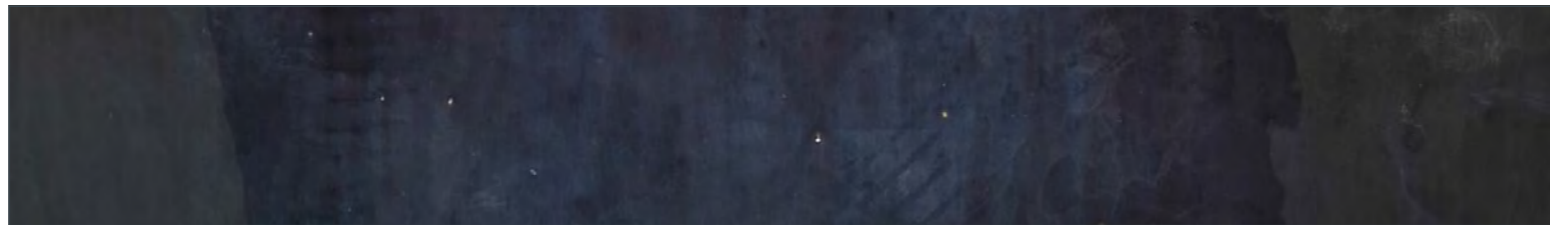

Ceramics
Mystic
6MYS

36



New
Collection

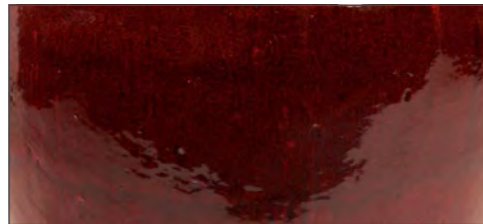

Ceramics
Sepia
6SEP

38

New Models

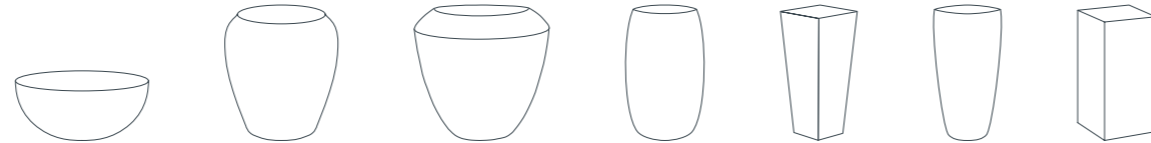



Metal Glaze

Ceramics
Turquoise
6TUR

42



New
Collection



Ceramics
White
6WIK

44



New
Models

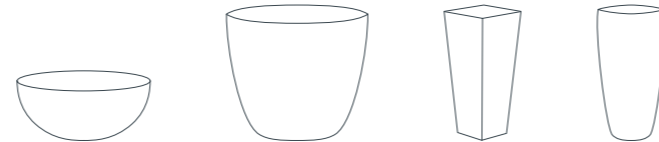

Ceramics
Sale

46



Mystic Ocean



Concrete



Rainbow



Cooper



Oxblood Red



Waterjar

Recommendations

Indoor

- For soil**
- Fill up the planter with styrofoam, depending on the height of the planter.
 - Cover the remaining 35-cm with a waterproof liner or pond plastic.
 - Place a water meter on the bottom.
 - Place a 10-cm layer of granules.
 - We recommend using felt or separation-cloth between the granules and the soil.
 - Fill up the rest with soil and insert the plant in it.
 - You can cover the substrate with decorative stones if you like.

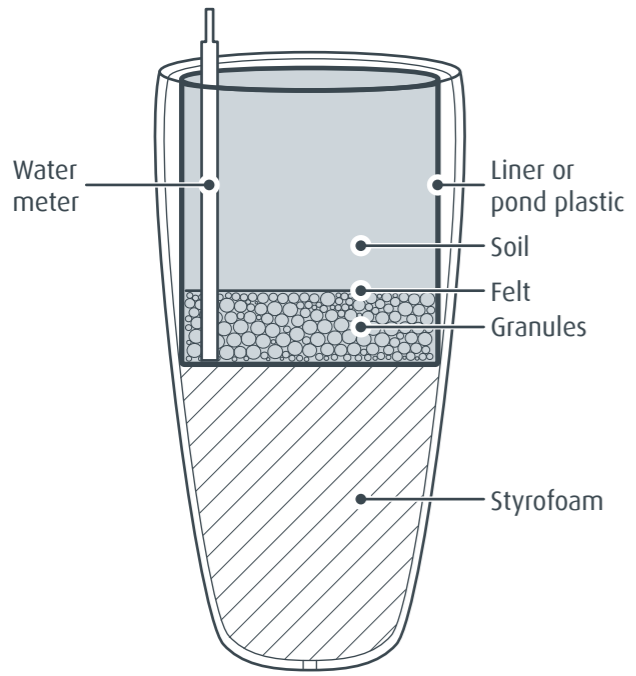

- For hydroculture**
- Fill up the planter with styrofoam, depending on the height of the planter.
 - Cover the remaining 23-cm with a waterproof liner or pond plastic.
 - Place a water meter on the bottom.
 - Insert the plant including the cultivation pot.
 - Fill up the rest with granules.
 - You can cover the substrate with decorative stones if you like.

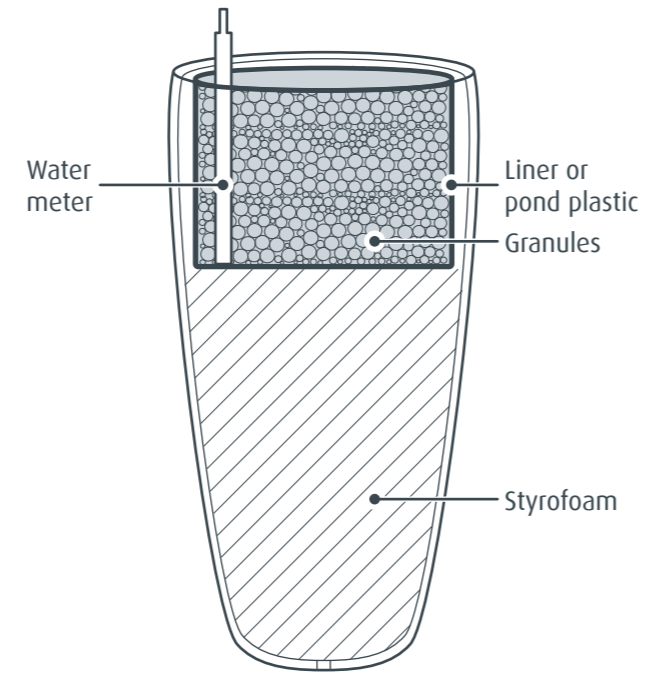

Outdoor

- We recommend to cover the hole in the bottom with felt or separation-cloth.
- Place a 10-cm layer of granules.
- We recommend using felt or separation-cloth between the granules and the soil.
- Fill up the rest with soil and insert the plant in it.
- You can cover the substrate with decorative stones if you like.

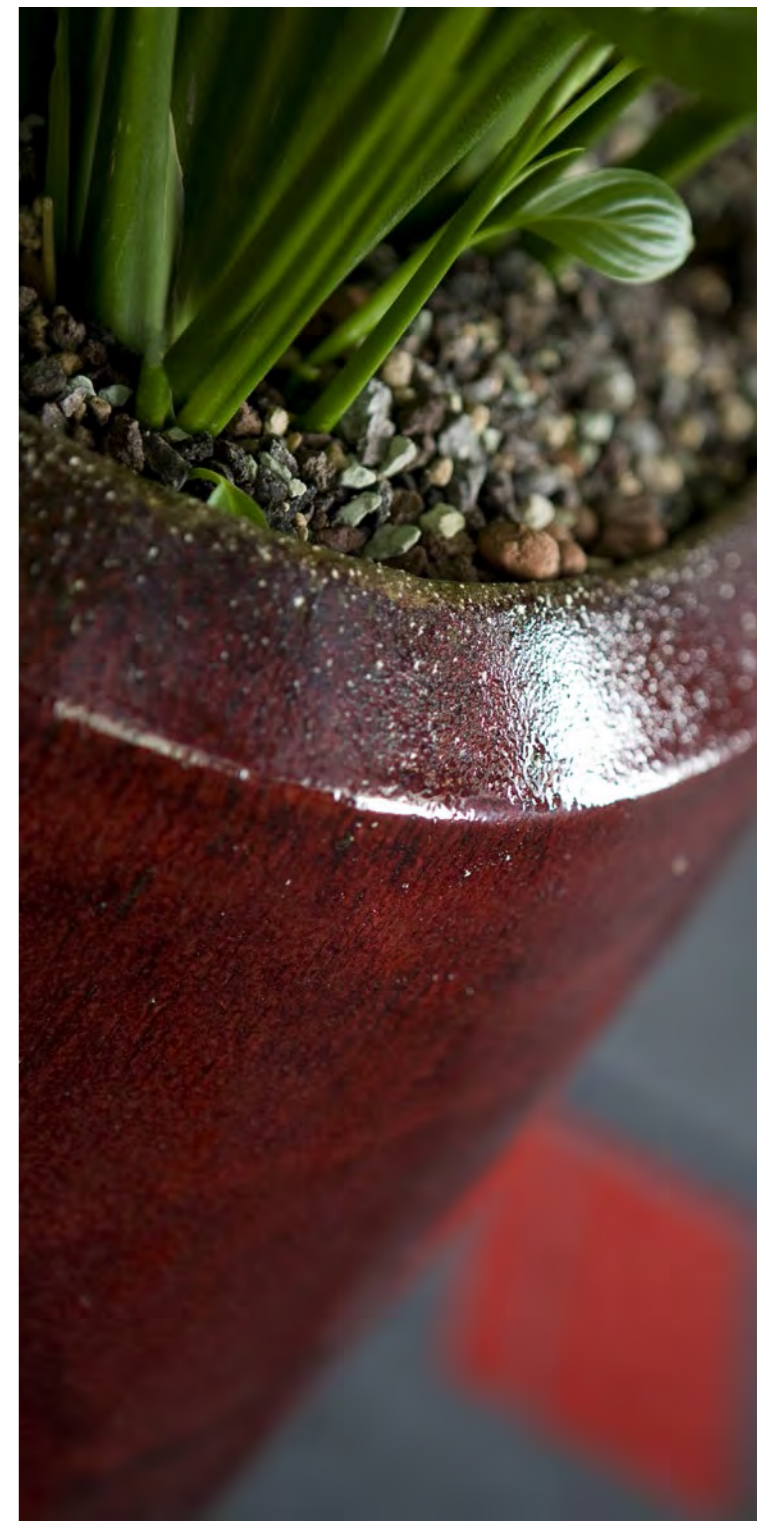
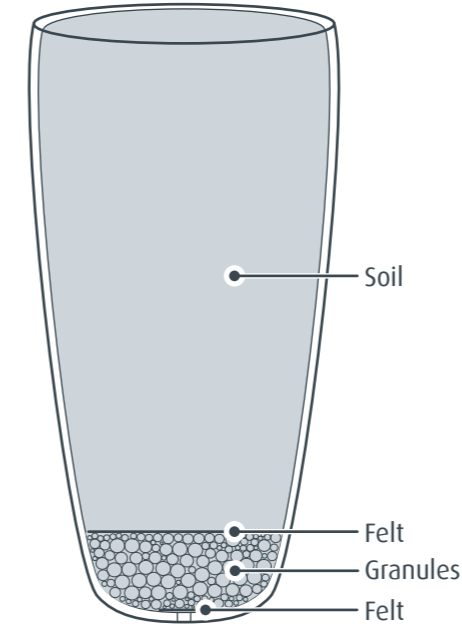

Terrapalme

Home and Garden Design

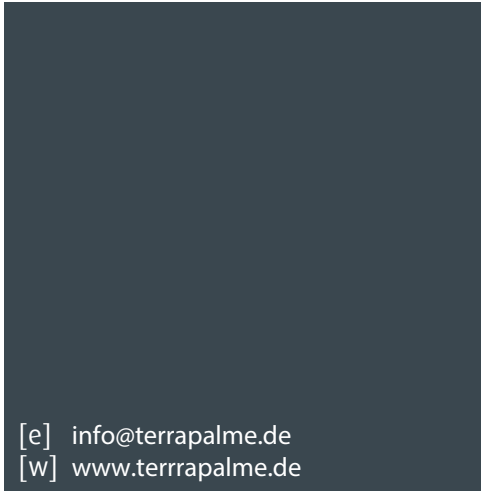

[e] info@terrapalme.de
[w] www.terrapalme.de